

**KEMENOVIC d.o.o.**

Hidro i toplinske izolacije

10250 ZAGREB-Lučko, Puškarićeva 104a

tel:(01) 65 30 812, 65 30 813; fax: 65 30 814

Radno vrijeme: pon-pet 8.00-16.00 h, subota 8.00-13.00 h

mail: info@kemenovic.hr; web: www.kemenovic.hr

## CJENIK PROFILA OD STIROPORA

Cijene izražene u kn sa PDV-om

### PROZORSKI PROFILI

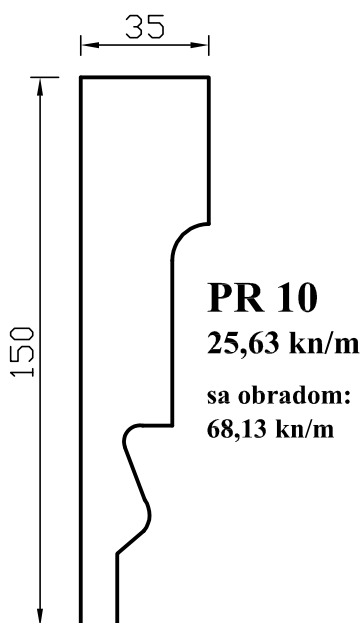
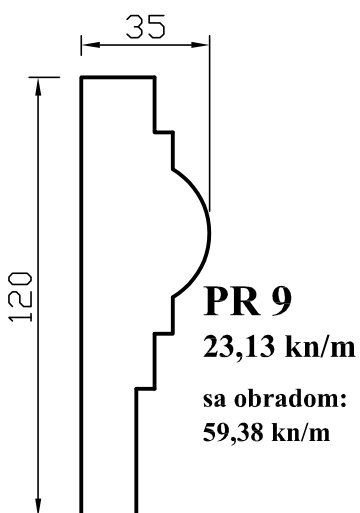
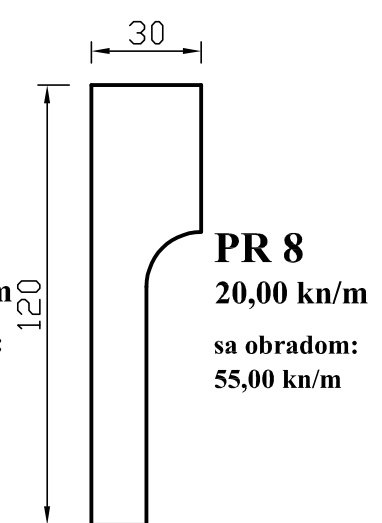
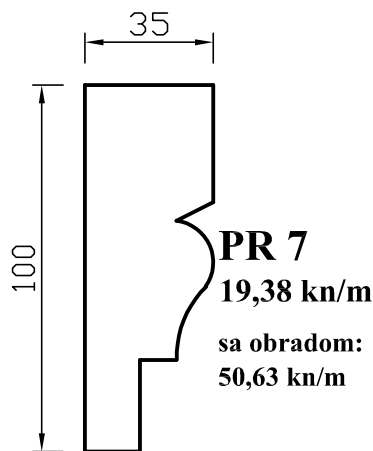
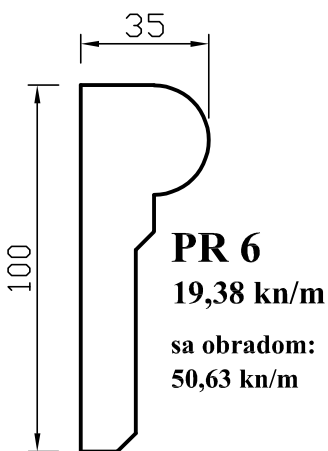
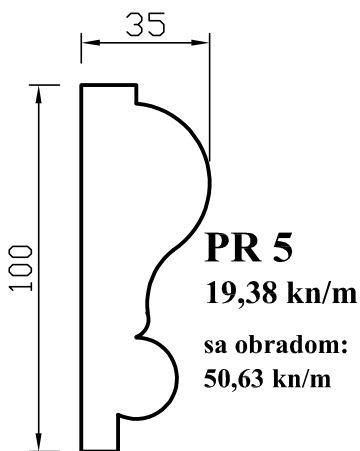
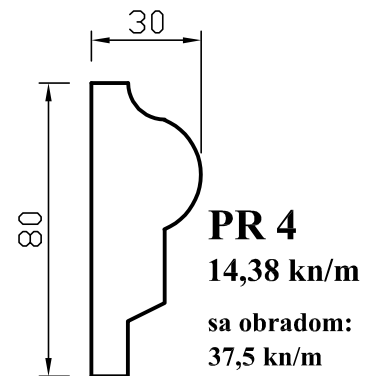
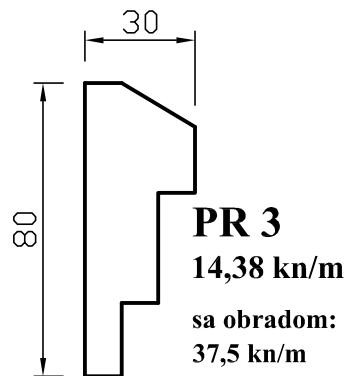
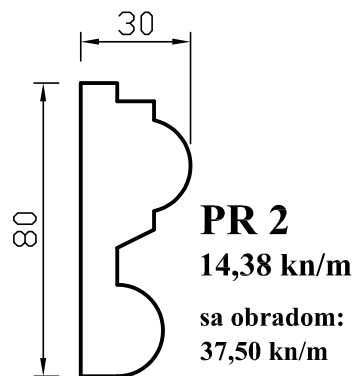
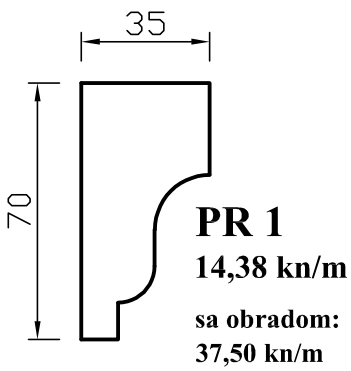

- cijene su izražene u kn/m  
**sa PDV-om**

- profili su dužine 2 m, EPS 200 (30 kg/m<sup>3</sup>)  
- dimenzije su izražene u mm

- mogućnost izmjene dimenzija i oblika  
profila po narudžbi

- nudimo obradu profila specijalnim  
premazom koji je nužan kao zaštita od  
vanjskih utjecaja

# PROZORSKI PROFILI - NOVO

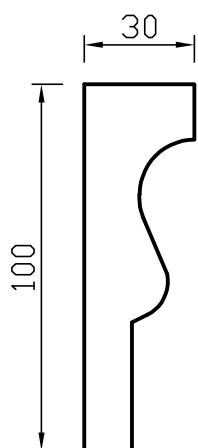

**PR 11**  
18,75 kn/m  
sa obradom:  
48,75 kn/m

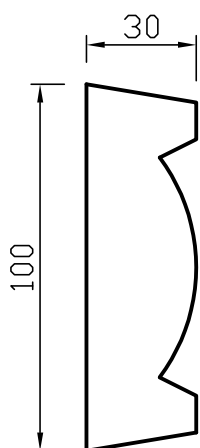

**PR 12**  
18,75 kn/m  
sa obradom:  
48,75 kn/m

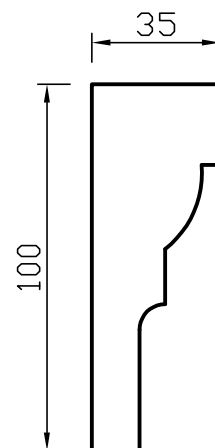

**PR 13**  
19,38 kn/m  
sa obradom:  
50,63 kn/m

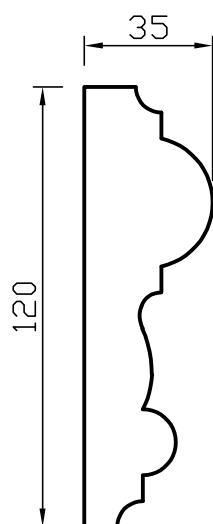

**PR 14**  
23,13 kn/m  
sa obradom:  
59,38 kn/m

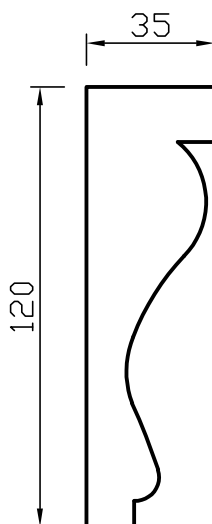

**PR 15**  
23,13 kn/m  
sa obradom:  
59,38 kn/m

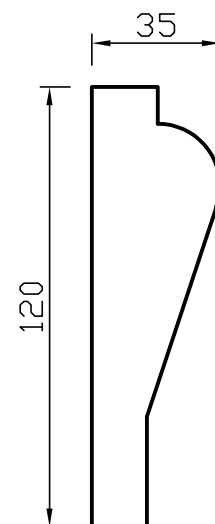

**PR 16**  
23,13 kn/m  
sa obradom:  
59,38 kn/m

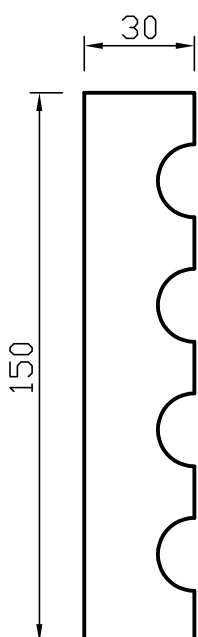

**PR 17**  
24,38 kn/m  
sa obradom:  
65,63 kn/m

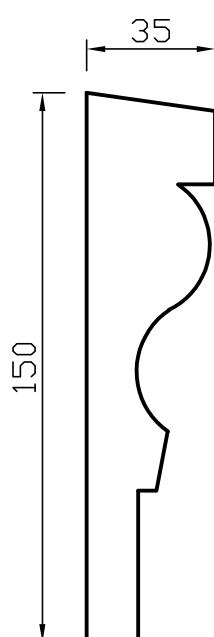

**PR 18**  
25,63 kn/m  
sa obradom:  
68,13 kn/m

- cijene su izražene u kn/m  
**sa PDV-om**

- profili su dužine 2 m, EPS 200 (30 kg/m<sup>3</sup>)  
- dimenzije su izražene u mm

- mogućnost izmjene dimenzija i oblika  
profila po narudžbi

- nudimo obradu profila specijalnim  
premazom koji je nužan kao zaštita od  
vanjskih utjecaja

## PODPROZORSKI PROFILI

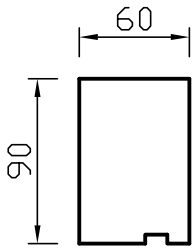

**PPR 1**  
25,63 kn/m  
sa obradom:  
60,63 kn/m

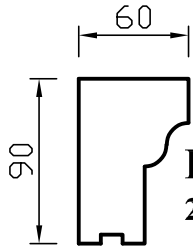

**PPR 2**  
25,63 kn/m  
sa obradom:  
60,63 kn/m

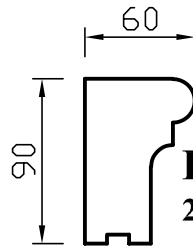

**PPR 3**  
25,63 kn/m  
sa obradom:  
60,63 kn/m

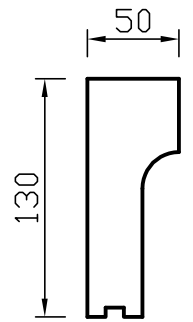

**PPR 4**  
30,00 kn/m  
sa obradom:  
71,25 kn/m

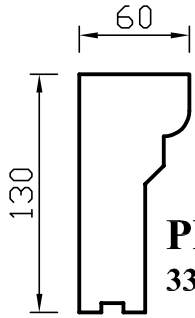

**PPR 5**  
33,75 kn/m  
sa obradom:  
77,50 kn/m

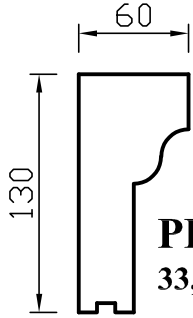

**PPR 6**  
33,75 kn/m  
sa obradom:  
77,50 kn/m

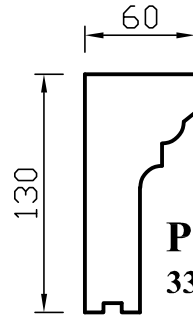

**PPR 7**  
33,75 kn/m  
sa obradom:  
77,50 kn/m

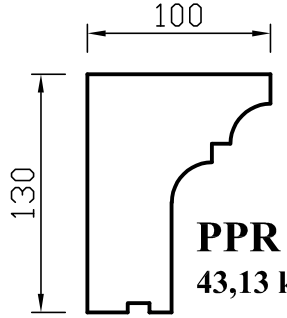

**PPR 8**  
43,13 kn/m  
sa obradom:  
96,25 kn/m

## KROVNI VIJENCI

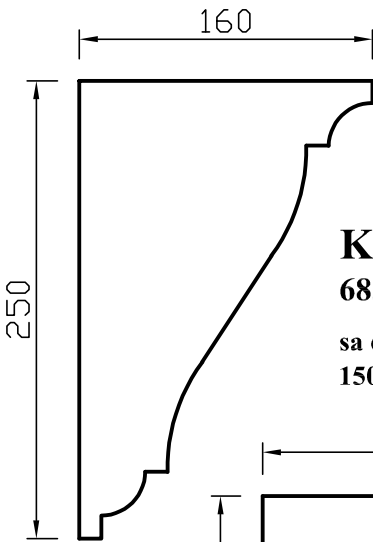

**KV 1**  
68,75 kn/m  
sa obradom:  
150,63 kn/m

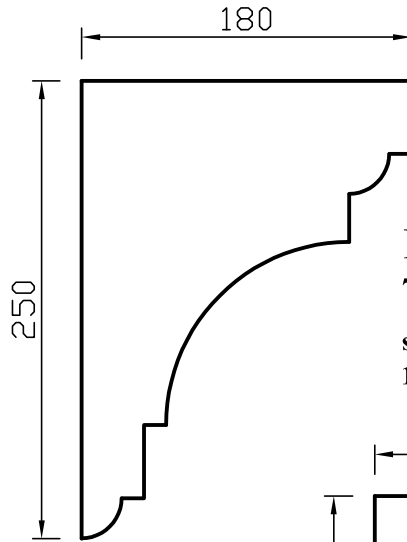

**KV 2**  
74,38 kn/m  
sa obradom:  
161,25 kn/m

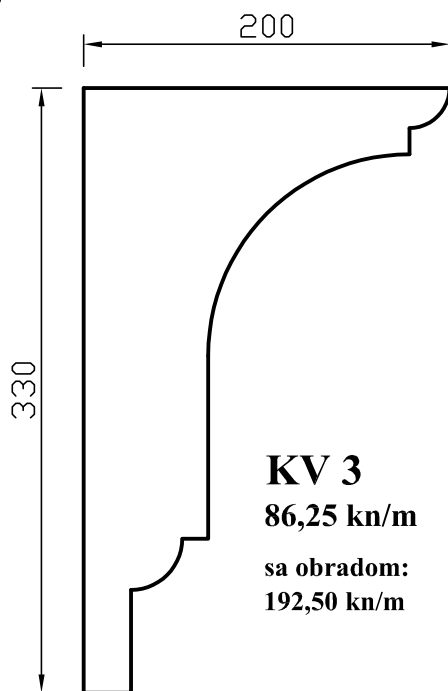

**KV 3**  
86,25 kn/m  
sa obradom:  
192,50 kn/m

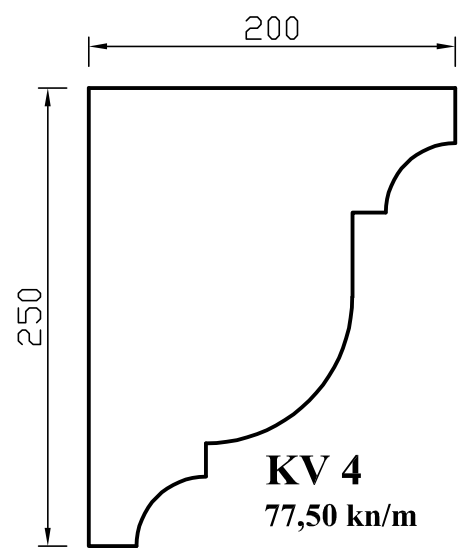

**KV 4**  
77,50 kn/m  
sa obradom:  
167,50 kn/m

- cijene su  
izražene u kn/m  
sa **PDV-om**

- mogućnost izmjene dimenzija i  
oblika profila po narudžbi

## RUBNI KAMENI

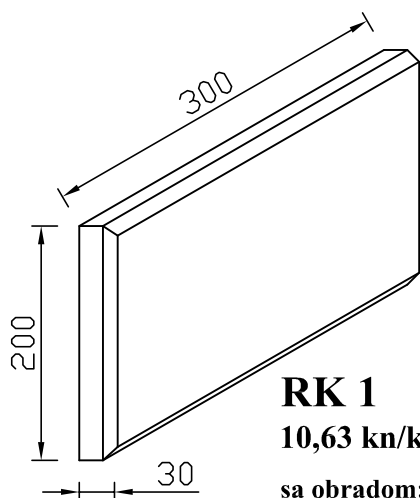

**RK 1**  
10,63 kn/kom  
sa obradom:  
33,13 kn/kom

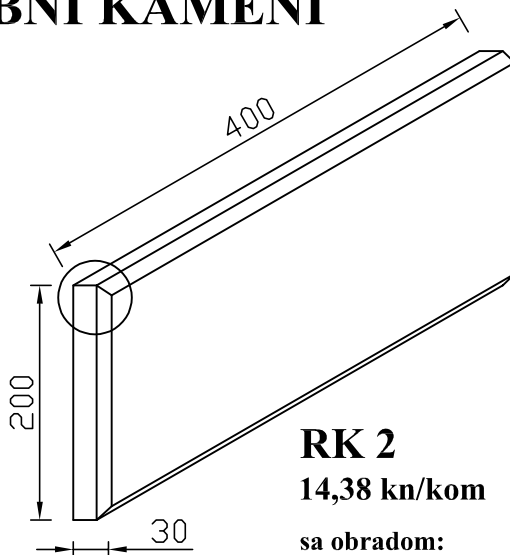

**RK 2**  
14,38 kn/kom  
sa obradom:  
44,38 kn/kom

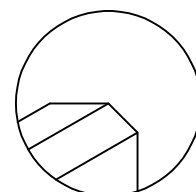

**Tip A**

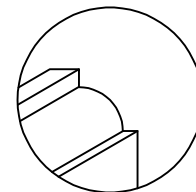

**Tip B**

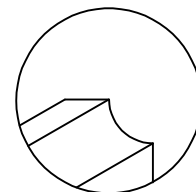

**Tip C**

## UKRASNI KAMENI

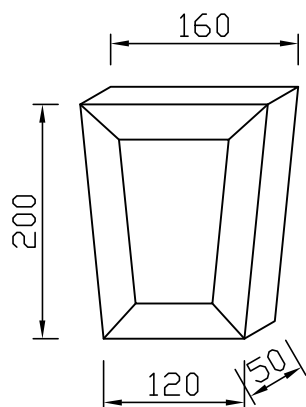

**UK 1A**  
23,75 kn/kom  
sa obradom:  
45,63 kn/kom

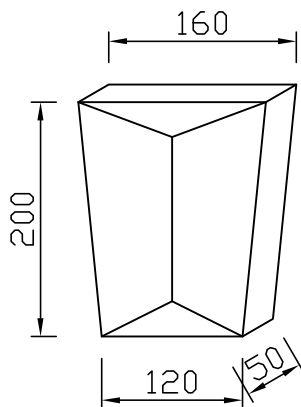

**UK 1B**  
23,75 kn/kom  
sa obradom:  
45,63 kn/kom

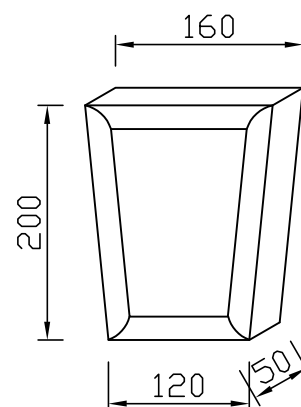

**UK 1C**  
23,75 kn/kom  
sa obradom:  
45,63 kn/kom

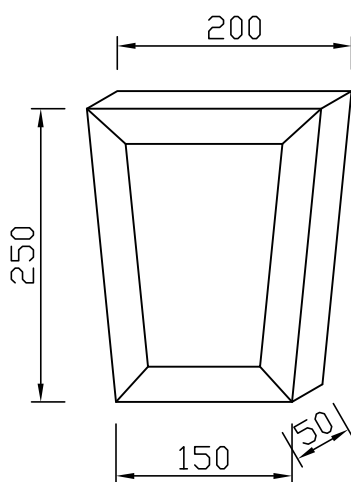

**UK 2A**  
36,25 kn/kom  
sa obradom:  
70,00 kn/kom

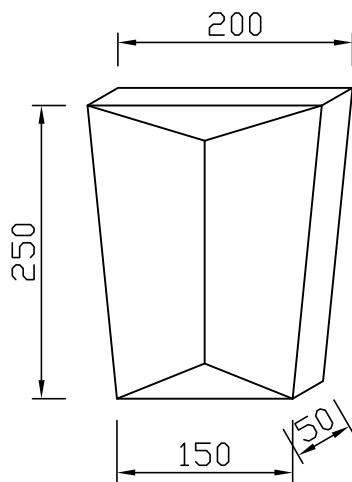

**UK 2B**  
36,25 kn/kom  
sa obradom:  
70,00 kn/kom

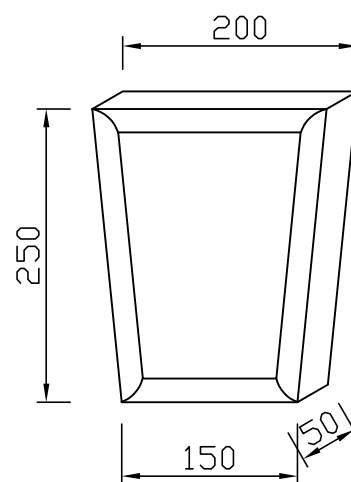

**UK 2C**  
36,25 kn/kom  
sa obradom:  
70,00 kn/kom